

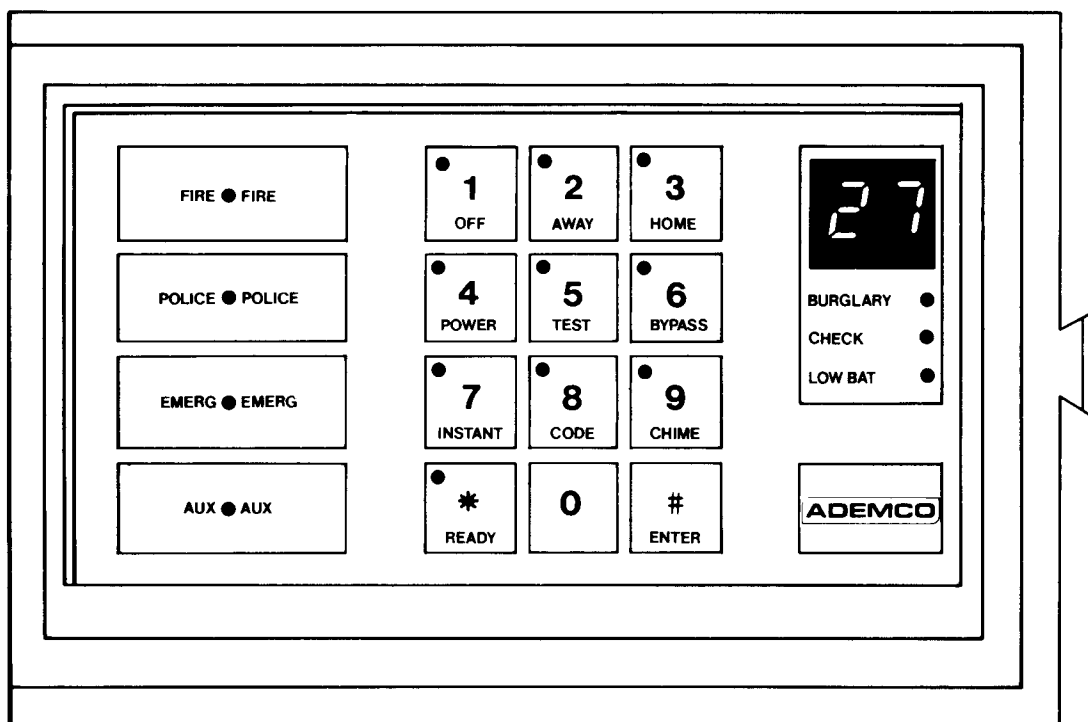

ALERT II

Wireless Residential Protection System



USER'S MANUAL

TABLE OF CONTENTS

INTRODUCTION & GLOSSARY	1
THE SYSTEM'S MAJOR COMPONENTS	2
KEY TO SYSTEM FUNCTIONS AND DISPLAYS	4
KEY TO AUDIBLE SIGNALS	8
BURGLARY PROTECTION	9
Arming Your Burglary System	9
Four-Digit Security Access Codes	9
Delay Zone Entry and Exit Times	10
Arming While Inside Your Home	10
Arming When Leaving Your Home (With No One Remaining At Home).....	10
Disarming Upon Entering Your Home	11
Disarming While Inside Your Home	11
Chime Annunciation	11
FIRE PROTECTION	12
Operation of Your Fire Alarm System	12
NATIONAL FIRE PROTECTION ASSOCIATION'S RECOMMENDATIONS ON SMOKE DETECTORS	13
EMERGENCY EVACUATION	14
Draw Your Own Evacuation Plan	15
EMERGENCY ACTION	16
How To Sound An Audible Panic Alarm	16
How To Sound A Silent Emergency Alarm	16
How To Sound An Auxiliary Panic Alarm	17
In the Event Of An Emergency	18
EMERGENCY PHONE NUMBERS	19
TESTING PROCEDURES	20
How To Test Your Burglary System.....	20
How To Test Your Fire Alarm System	21
TROUBLE CONDITIONS	21
Responding To A Low Battery Condition	21
Responding To A Supervision Check Condition	22
How To Bypass A Malfunctioning Sensor.....	23
QUESTIONS AND ANSWERS	
ABOUT YOUR SECURITY SYSTEM	24
SYSTEM REFERENCE CHART	26
HOMEOWNER'S INSURANCE	
PREMIUM CREDIT REQUEST FORM	27
THE LIMITATIONS OF YOUR ALARM SYSTEM	29
FEDERAL COMMUNICATIONS	
COMMISSION (FCC) STATEMENT	30
LIMITED WARRANTY	31

INTRODUCTION

Congratulations on your ownership of the ALERT II. You have made a wise decision in choosing it, for it offers the best security protection available to today's homeowner.

Basically, ALERT II offers you three forms of protection: burglary, fire and emergency. To realize the system's full potential, it is important that you and your family feel comfortable in operating it.

This manual is a step-by-step guide that will fully acquaint you with ALERT II's features and benefits. It defines the components and their functions, describes their operation, and acquaints you with normal and emergency procedures.

The following glossary of terms used throughout the manual will avoid any confusion.

GLOSSARY

ARM/DISARM:

"Armed" simply means that the burglary portion of your system is turned ON, and is in a state of readiness. "Disarmed" means that the burglary system is turned OFF, and must be rearmed to become operational. However, even in the "disarmed" state, the "Emergency" and "Fire" portions of your system will still be operational.

KEYPAD:

This is the area on your master console, or any remote unit, containing numbered pushbuttons similar to those on telephones or calculators. These keys control the arming or disarming of the system, and perform other functions which will be described.

SENSORS:

Alarm initiating devices that have been installed to provide burglary and fire protection (e.g., door/window transmitters, passive infrared (body heat) intrusion detectors, smoke detectors). Each sensor has its own ID number, assigned at the time of installation.

ZONE:

A specific area of burglary protection.

BYPASS:

To disarm a specific area of burglary protection while leaving other areas operational.

DELAY ZONE:

An area of protection containing doors household members most frequently use to enter or exit (typically, a front door, back door, or door from the garage into the house). The delay zone allows sufficient time for authorized entry or exit without activating the alarm. Consult your installer for the entry and exit delay times that have been set for your system during installation and record them on page 10.

SYSTEM'S MAJOR COMPONENTS

Your system consists of a Receiver/Control, at least one Master Console (but no more than three), any desired number of optional Remote Wireless Keypads, various battery-operated sensor/transmitters which serve to provide perimeter and interior burglary protection, plus a selected number of strategically placed smoke detector/transmitters designed to provide fire detection.

THE RECEIVER/CONTROL

The Receiver/Control is the "brains" of your system. Located out of sight, it receives signals, analyzes them, and initiates alarms. (Alternatively, if provisions have been made, it may transmit a silent alarm to your police department or to a central alarm monitoring service.)

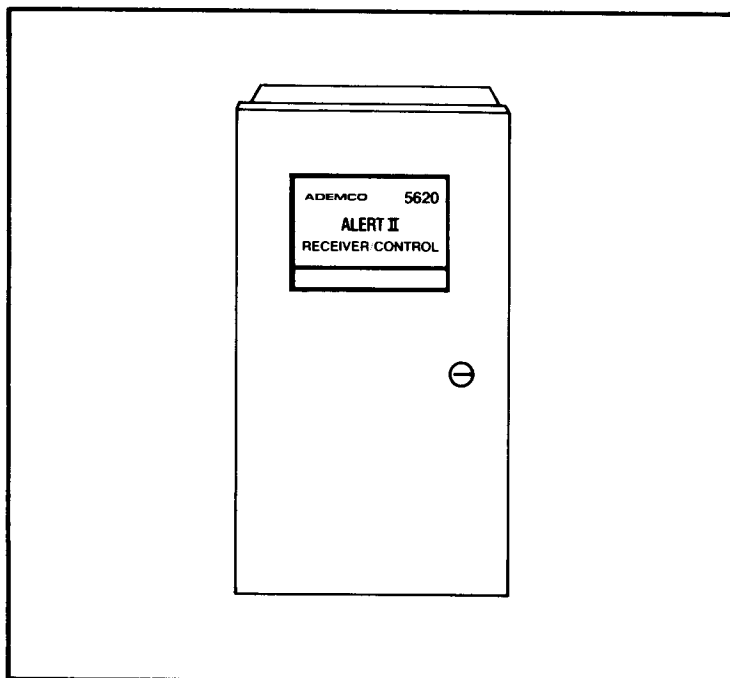

THE MASTER CONSOLE

The Master Console is centrally located to suit your convenience. Its individual indicator lights display messages that inform you of the status of your system. The console enables you to arm or disarm the burglary portion of your system, and is also the source of alarm and warning sounds.

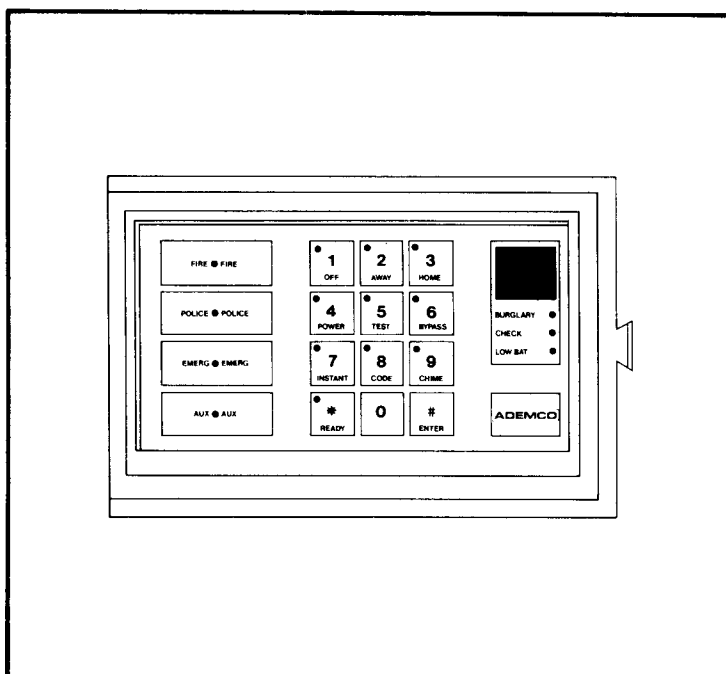

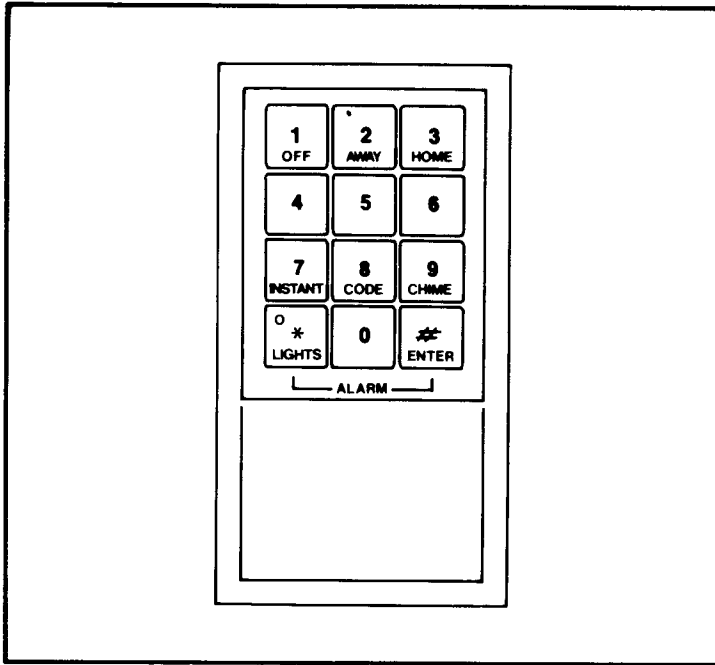

REMOTE WIRELESS KEYPAD(S)

These are optional units providing additional locations from which you can arm or disarm your burglary system. Each wireless keypad has an indicator light that provides a visual indication that a key has been successfully pressed.

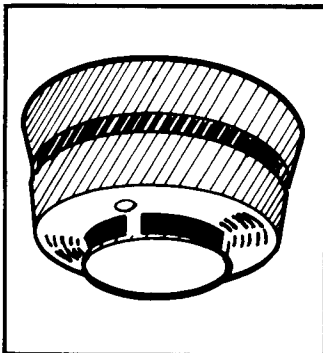

WIRELESS PHOTOELECTRIC SMOKE DETECTOR

The System can accommodate up to four wireless photoelectric smoke detectors. When a low battery condition is detected, the signal is sent to the Receiver/Control and the local internal sounder in the Smoke Detector is activated. When an

actual fire alarm condition is detected, a "fire alarm" message is sent and repeated as long as smoke is present and the local internal sounder is activated.

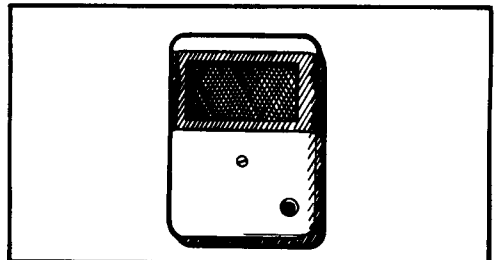

PASSIVE INFRARED (BODY HEAT) INTRUSION DETECTORS

Offer economical and stable interior protection. The body heat of an intruder will activate these sensors. The units can be corner mounted, wall mounted or flush mounted.

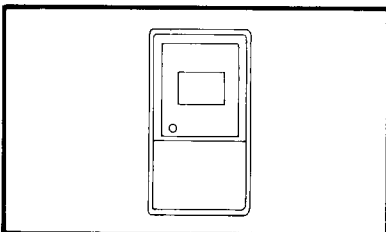

PERSONAL EMERGENCY TRANSMITTERS

The Emergency (Panic) Transmitters may be carried about the protected area in a pocket or purse. It is programmable for reporting either Police or Emergency alarms. Pressing the button on the unit will trigger an alarm.

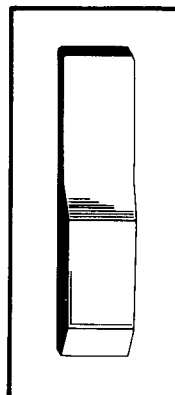

PERIMETER/SENSOR TRANSMITTERS

The Slimline Sensor/Transmitter is perfect for protecting doors and windows, its narrow design permitting mounting on most door jambs and window frames.

KEY TO SYSTEM FUNCTIONS AND DISPLAYS

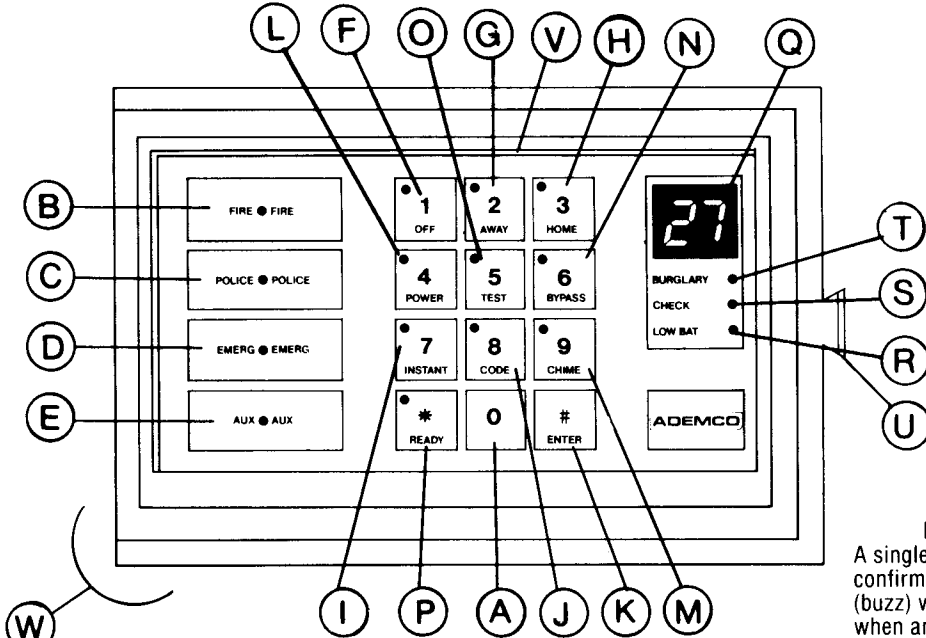

MASTER CONSOLE

NOTE:
A single low-level confirmation tone (buzz) will be heard when any key (0-9, READY and ENTER) on the Console keypad is pressed.

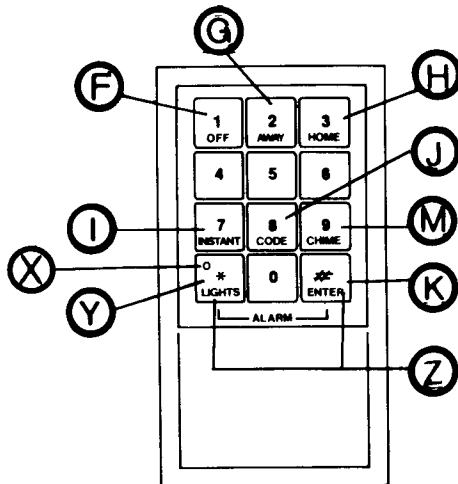

KEYPAD ENTRIES

(Console and Wireless Keypad)
While entries are being made, if more than 2 seconds elapse between successive key depressions, all prior entered information will be erased, thus requiring the entry sequence to be started again.

OPTIONAL REMOTE WIRELESS KEYPAD

APPLICABLE TO:

KEY/DISPLAY FUNCTIONS

	MASTER CONSOLE	REMOTE WIRELESS KEYPAD (Optional)
A. KEYS 0-9 are used to enter your individual four-digit Security Access Code.	YES	YES
B. FIRE/FIRE KEYS & INDICATOR LIGHT. Simultaneous depression of both keys sounds a FIRE alarm and lights the Red indicator; causes a loud, interrupted, rapidly-alternating, two-tone siren sound. (Optional outside bell: Pulsating ringing sound.) The indicator will also light for alarms triggered by fire detection devices in the system.	YES	NO
C. POLICE/POLICE KEYS & INDICATOR LIGHT. Depending on configuration determined at time of system installation, simultaneous depression of both keys will trigger either a silent POLICE alarm (if connected to a police agency or central alarm monitoring service) or an audible POLICE alarm; a loud, continuous, two-tone siren sound. (Optional outside bell: Steady ringing sound.) The Red indicator lights only for audible Police alarm.	YES	NO
D. EMERG/EMERG KEYS & INDICATOR LIGHT. Simultaneous depression of both keys sounds an EMERGENCY alarm and lights the Red indicator. The indicator will also light for optional remote emergency transmitters. Causes a loud, continuous, two-tone siren sound. (Optional outside bell: Steady ringing sound.)	YES	NO
E. AUX/AUX KEYS & INDICATOR LIGHT. In a non-UL listed system installation, simultaneous depression of both keys may either sound an AUXILIARY alarm, a loud, interrupted, rapidly alternating, two-tone siren sound (or pulsating ringing sound if an optional outside bell is used), or remotely turn on selected lights in the home. The Red indicator will also light. NOTE: To turn off alarm sounding after activation of one of the above functions, enter your access code and depress the OFF key.	YES	NO
To accomplish functions F through J and M through O, you must enter your Security Access Code BEFORE depressing the designated key(s).		
F. OFF KEY & INDICATOR LIGHT. Disarms the burglary portion of your security system, silences any alarm in progress, turns off audible warnings for trouble, low battery, loss of AC power, and clears any lighted warning indicators. The Green indicator lights while the system is in this mode. (Code + OFF)	YES	YES, but no indicator light.
G. AWAY KEY & INDICATOR LIGHT. Completely arms the burglary portion of your system. The Red indicator lights to confirm successful arming of the AWAY function, and stays lit as long as the system remains in this mode. (Code + AWAY)	YES	YES, but no indicator light.
H. HOME KEY & INDICATOR LIGHT. Arms the burglary portion of your system with the exception of the interior zone of protection. The Red indicator confirms successful arming using the HOME function, and stays lit as long as this mode prevails. (Code + HOME)	YES	YES, but no indicator light.
I. INSTANT KEY & INDICATOR LIGHT. (Primarily for use when the family is in to stay.) If this key is depressed after pressing either the HOME or AWAY keys, the entry delay period will be eliminated, causing an instant intrusion alarm should someone come through a main door. The Amber indicator will light as a reminder that the Delay Zone is now an Instant Zone. [Code + AWAY (or HOME) + INSTANT]	YES	YES, but no indicator light.
J. CODE KEY & INDICATOR LIGHT. Depressing this key allows the immediate entry of a new temporary four-digit Security Access Code that can be given to babysitters, domestics, or others who require interim access to your home. The Amber indicator lights to show that system status may be changed by use of a temporary code. (Code + CODE + Temporary Code)	YES	YES, but no indicator light.
K. ENTER KEY. When depressed after one of the other mode or function keys, this optional usage key will terminate the two-second interval normally allotted to mode entries, so that the desired function can be executed immediately (rather than two seconds later).	YES	YES.

APPLICABLE TO:

KEY/DISPLAY FUNCTIONS

	MASTER CONSOLE	REMOTE WIRELESS KEYPAD (Optional)
L. POWER INDICATOR LIGHT (Green). Indicates the presence of household AC power.	YES	NO
M. CHIME KEY & INDICATOR LIGHT . In disarmed (OFF) state, enter Access Code, then depress key to turn on CHIME Mode. Any opening of a sensor in the Delay Zone (main doors) and/or Perimeter Zone (windows, infrequently-used doors) will produce a tone from the speaker(s) at any console(s), thereby signalling an entry. The Amber indicator lights while the system is in this mode. Repetition of this key sequence turns off the CHIME mode. (Code + CHIME)	YES	YES, but no indicator light.
N. BYPASS KEY & INDICATOR LIGHT . Depress either the AWAY or HOME keys, then the BYPASS KEY. This turns off protection monitoring from any currently violated burglary sensor (e.g., an improperly-functioning sensor that is preventing the arming of the system, or an intentionally violated sensor that likewise inhibits the arming of the rest of the system). The Amber indicator will light to reveal that your burglary protection is incomplete because the monitoring of one or more protective sensors has been temporarily discontinued. [Code + AWAY (or HOME) + BYPASS]	YES	NO
O. TEST KEY & INDICATOR LIGHT . In disarmed (OFF) state, enter Access Code, then depress key to put entire security system in a TEST mode (the Amber indicator will light). In this mode, every sensor violation and restoration (fire, burglary or panic) causes two short tones from the speaker(s) at the Master Console(s). (Code + TEST)	YES	NO
P. READY KEY & INDICATOR LIGHT . The Green indicator reveals the status of your burglary protection during the disarmed state. If lit, all sensors are closed/ready for arming. If not lit (and neither the HOME nor AWAY indicators are lit) your burglary system is not ready for arming. In this event, do not arm your system (see "How to Bypass a Malfunctioning Sensor" on page 23). Normally, the two-digit numeric display will not indicate which sensors are violated except when an attempt is made to arm the system. To view the individual sensors' status at other times, press the READY key.	YES	NO
Q. SENSOR IDENTIFICATION DISPLAY . This two-digit numeric display identifies violated burglary sensors at arming time or subsequent to an alarm for determination of entry point. The display also identifies any sensor that has a low battery condition or requires checking because of failure to transmit regular check-in signals. Numbers 01 to 25 identify burglary sensors. Numbers 26 to 29 identify burglary or fire sensors as a function of your specific installation configuration. Numbers 30 and 31 identify a low battery condition at portable panic transmitters. "00" identifies a special wired zone that may have been configured by your installer as a Delay, Perimeter or Interior Zone. "00" also identifies low battery conditions at any remote wireless keypad.	YES	NO
R. "LOW BAT" MESSAGE INDICATOR (Red). Lights when a low battery indication is received from one or more burglary or fire sensors, panic transmitters, or remote wireless keypads. It appears in conjunction with a numeric display (see Q.) to identify the problem sensor.	YES	NO
S. "CHECK" MESSAGE INDICATOR (Red). Lights when your Receiver/Control fails to receive regular check-in messages from one or more burglary or fire sensors. It appears in conjunction with a numeric display (see Q.) to identify the problem sensor.	YES	NO

APPLICABLE TO:

KEY/DISPLAY FUNCTIONS

	MASTER CONSOLE	REMOTE WIRELESS KEYPAD (Optional)
T. "BURGLARY" MESSAGE INDICATOR (Red). Lights when an intrusion has been detected during the armed period. It remains lit after the burglary alarm sounder has silenced, as a warning upon the return home. This display appears in conjunction with a numeric display (see Q.) to identify the violated sensor.	YES	NO
U. PULL-OUT DRAWER. Contains abbreviated operating instructions; also contains numbered sensor identification information on cards, so that number on the Master Console can be quickly translated into the sensor's location.	YES	NO
V. KEYPAD ILLUMINATION LIGHT. Lit for convenient use of the Master Console in a darkened room.	YES	NO
W. INTERNAL SPEAKER. Source of audible internal warning and confirmation sounds, as well as alarms.	YES	NO
X. TRANSMISSION LIGHT (Red). Lights to indicate that the command from the key depressed is being transmitted by radio link to the Receiver/Control.	NO	YES, located on LIGHTS key (Y)
Y. LIGHTS KEY & INDICATOR. When held depressed for at least 2 seconds, this key will turn on selected lights in the home or sound an alarm (as set up at time of installation). Red indicator on this key lights when any key is depressed to indicate that the keypad is transmitting.	NO	YES
Z. LIGHTS & ENTER KEYS. Depending on configuration determined at time of installation, pressing both keys at the same time will trigger either a silent POLICE alarm (if connected to a police agency or central alarm monitoring service) or an audible POLICE alarm.	NO	YES

KEY TO AUDIBLE SIGNALS

INTERNAL SPEAKER SOUND	(IF USED) EXTERIOR SOUND	CAUSE	DISPLAY(S) PRESENT
LOUD, INTERRUPTED, RAPIDLY ALTERNATING TWO-TONE SIREN SOUND	Same siren sound or pulsing bell ring (if bell used)	FIRE/AUXILIARY ALARM*	FIRE or AUXILIARY indicator lit plus the number of the detector in alarm (i.e., 26 thru 29).
LOUD, CONTINUOUS, SLOWLY ALTERNATING TWO-TONE SIREN SOUND	Loud, continuous, slowly alternating two-tone siren sound** or Loud, continuous, rapidly alternating two-tone siren sound**. Steady bell ring in both cases (if bell used).	BURGLARY/AUDIBLE POLICE/EMERGENCY ALARM	BURGLARY message indicator, EMERG indicator or POLICE indicator lit. If BURGLARY lit, the number of the detector in alarm will be displayed. (i.e., 1 thru 25 or 29).
ONE SHORT TONE (BEEP), NOT REPEATED	NONE	System was turned off or an attempt was made to arm the system when one or more sensors were faulted.	Green READY indicator may or may not be lit. Green OFF indicator lit.
ONE SHORT TONE (BEEP), REPEATED EVERY 30 SECONDS	NONE	Reminder that system is in the TEST mode.	Amber TEST indicator lit.
TWO SHORT TONES (BEEPS)	NONE	<ol style="list-style-type: none"> 1. System has just been armed in the AWAY mode. 2. System has just been put in TEST mode. 3. Sensor activated or deactivated while system is in the TEST mode. 	Red AWAY indicator lit. Amber TEST indicator lit. If the sensor is a burglary sensor, the number of the sensor will be displayed when the sensor is activated.
THREE SHORT TONES (BEEPS)	NONE	System has just been armed in the HOME mode.	Red HOME indicator lit.
SHORT "BUZZ" TONE	NONE	Confirmation tone for each key depressed on keypad.	NONE
ONE SHORT TONE (BEEP)	NONE	System is disarmed and in the CHIME mode and a sensor in either the delay or perimeter zone has just been activated.	The number of the sensor is displayed. Amber CHIME indicator lit.
RAPIDLY PULSING TONES (BEEPS)†	NONE	<ol style="list-style-type: none"> 1. Failure to receive regular check-in message from one or burglary or fire sensors. 2. Low battery detection in one or more devices. 3. AC power has been lost for more than an installer-programmed interval (0-32 minutes.) 	CHECK message indicator lit plus the number of the detector failing to report (i.e., 1 thru 29). BATTERY message indicator lit plus the number of the device: (Refer to data card in Console drawer for ID numbers of devices in your system.) Green POWER indicator not lit.

*NOTE: In a UL Listed system there is no AUXILIARY alarm capability.

**As programmed by installer at time of installation.

RAPID PULSING TONES (BEEPS)[†] (CONT'D)		4. A memory of alarm that is activated during entry.	BURGLARY message indicator or FIRE, POLICE, EMERG or AUX indicator lit, plus the number of the sensor/transmitter that caused either the burglary or fire alarm
SLOWLY PULSING TONE (BEEPS)	NONE	Audible warning of your entry during the Entry Delay period (if no prior alarm has occurred during your absence).	No Message Display
CONTINUOUS LOW TONE ^{††}	NONE	Prolonged AC power outage has resulted in system shutdown. System is inoperative.	Green POWER indicator not lit. OC will appear in display area.

[†] Any pulsing tones or alarm sounds from the Console will be immediately silenced when the first digit of your security code is keyed (any alarms from external sounders will continue, however). This will allow the confirmation (feedback) tone emitted by the Console to be heard as each key is depressed. If the security code plus OFF are not keyed within 10 seconds, the pulsing tones or alarm sounds will resume at the Console.

^{††} The continuous tone can be silenced by depressing the "4" key, but note that until AC power is restored and the control's battery sufficiently recharged, the system will be incapable of sounding and communicating alarms. After a sustained AC power outage, the battery may require a recovery period of up to 24 hours before the system is again fully operative.

BURGLARY PROTECTION

ARMING YOUR BURGLARY SYSTEM

Your system provides two levels of burglary protection: exterior and interior. The former guards door, windows, etc., sounding an alarm if one is opened by an intruder. Interior protection offers backup defense, sensing when an unauthorized person is moving about inside your home.

Exterior protection (only) can be used if you plan to remain inside your home but would like to have all exterior doors and windows protected against entry (HOME mode). This procedure is described in "ARMING WHILE INSIDE YOUR HOME". Full protection (exterior and interior) is desirable when no one is in the home (AWAY mode). This procedure is described in "ARMING WHEN LEAVING YOUR HOME (WITH NO ONE REMAINING AT HOME)".

FOUR-DIGIT SECURITY ACCESS CODES

At the time of installation, you chose a personal four-digit code, known only to members of your family, and programmed by your installer. ARMING and DISARMING of your burglary alarm system is accomplished by entering this code and the desired function (e.g., HOME, AWAY, etc.) at the Master Console and at any Remote Wireless Keypad.



As an additional safety feature, a secondary code may be utilized at any time. Household employees who, in your absence, must arm the system upon departure, can be provided with a different temporary code that allows arming and disarming and the use of other system functions. However, if the system was armed by the master code, the secondary code cannot override the master code to disarm the system. Your master code remains in effect even when a secondary code is present.

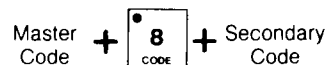

The secondary code can be entered, or changed, at the Master Console or at any Remote Wireless Keypad only if the master code is known, as follows: Enter the master code, depress the CODE key, then key in the desired temporary secondary code. To eliminate the secondary code, repeat this sequence, keying in the master code as the secondary code (Master Code + CODE + Master Code).

DELAY ZONE ENTRY AND EXIT TIMES

These are set by your installer during installation. They determine the number of seconds available for exit and entry through the delay zone when arming and disarming the burglary protection, to avoid setting off an alarm.

Record the delay times for your system here:

Exit Delay: _____ seconds (may be from 15 to 120 seconds, but no more than 60 seconds for a UL Listed household burglary application).

Entry Delay: _____ seconds (may be from 15 to 120 seconds, but no more than 45 seconds for a UL Listed household burglary application).

ARMING WHILE INSIDE YOUR HOME

1. **Check the Green READY Indicator light on your Master Console.** It should be on to indicate that your system is ready to be armed. Enter your security access code and depress the HOME key. The Red HOME Indicator light on the Master Console will illuminate and you will hear three tones (beeps) from your Master Console and any remote interior speaker(s). You have now ARMED successfully with the ability to walk freely through the interior of your home.

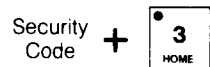

Note: If the Remote Wireless Keypad is used for arming, the arming procedure should be performed in close proximity to the Master Console so that its various indicator lights can be observed and the appropriate confirmation tones heard.

2. **"Delay Off" (Instant) Arming.** If you wish the act of opening one of your main access doors to instantly trigger an alarm (as might be the case when the family is sleeping), do the following: Enter your access code. Depress the HOME Key, and then the INSTANT Key. Both the Red HOME and the Amber INSTANT indicator lights will illuminate and you will hear three tones (beeps) from your Master Console and any remote interior speaker(s).

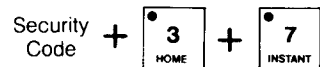

NOTE: If you wish to leave a door or window open intentionally, use the procedure in steps 3 and 4 of "How to Bypass a Malfunctioning Sensor" on page 23.

IMPORTANT: If the Green READY Indicator Light on your Master Console is not on, check the Sensor Identification Display after depressing the READY Key or after attempting to arm the system. A number appearing there indicates a violated sensor (and its location). The problem must be corrected before arming can take place. See "How to Bypass a Malfunctioning Sensor" on page 23.

ARMING WHEN LEAVING YOUR HOME (WITH NO ONE REMAINING AT HOME)

1. **Check the Green READY Indicator Light on your Master Console.** It should be on, indicating that the system is ready for arming.
2. **Enter your security access code and depress the AWAY Key.** The Red AWAY indicator light will illuminate and you will hear two tones (beeps) from your Master Console and any remote interior speaker(s), signifying that the system is ARMED. You have 15 to 120 seconds (as programmed at time of installation) to leave your home through your chosen exit door before such passage will cause an alarm to sound.

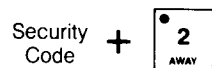

NOTE: If the system was in the HOME mode while you were at home, it is possible to arm it directly into the AWAY mode when you leave. However, if any violated sensors are present in the interior zone, the system will not arm AWAY and will disarm (both the HOME and AWAY indicator lights will be out).

DISARMING UPON ENTERING YOUR HOME

1. **Enter via a door in your Delay Zone.**
You will hear slowly pulsing tones (beeps) from your Master Console and any remote interior speaker(s) if no alarms had occurred while you were out. Depending on the programming at time of installation, you have 15 to 120 seconds to reach your Master Console or Remote Wireless Keypad and DISARM the burglary portion of your system.
2. **Enter your access code and depress the OFF key.** The Red AWAY indicator light will go out, the Green OFF Indicator Light will go on and you will hear a single tone (beep) from your Master Console and any remote interior speaker(s). You may open and close doors and windows, and move freely inside your home, without setting off an alarm.

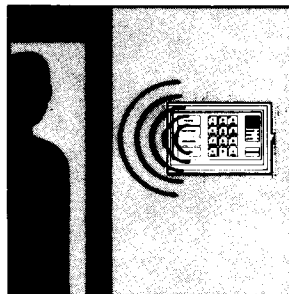

Security Code + 

NOTE: It is possible to arm the system directly into the HOME mode when you enter by keying your access code and depressing the HOME key.

IMPORTANT

BEFORE keying your access code, observe the BURGLARY Message Indicator on your Master Console. If it is lit, or if you hear **continuous, rapidly pulsing tones** (beeps) from your Console or any remote interior speaker, an intrusion has occurred during your absence. Leave your house immediately and contact the police from the nearest safe location.

When re-entering your house subsequently, the rapidly pulsing tones (resulting from a memory of

alarm) will be silenced as soon as you key the first digit of your access code. This will enable you to hear the confirmation tone emitted by the Console as each key on the keypad is pressed. You have approximately 10 seconds to enter your access code and press OFF, before the memory of alarm warning tones resume. Any numeric display that may be present (identifying a open sensor resulting from an intrusion during your absence) can be cleared by entering your access code and pressing OFF.

DISARMING WHILE INSIDE YOUR HOME

Go directly to the nearest Console or Keypad. Enter your access code and depress the OFF key. The Red HOME indicator light on the Master Console will go out, the Green OFF indicator light will go on and you will hear a single tone (beep) from your Master Console and any remote interior speaker(s). You may now open and close doors and windows, and move freely inside your home, without setting off an alarm.

While the system is DISARMED, the Green READY indicator light will go on and off as various sensors are activated by your normal household activities.

Security Code + 

NOTE: If, after turning your system off, you hear rapidly pulsing tones (beeps), the Master Console will display either a "CHECK" or "LOW BAT" message plus the Sensor Identification Number(s) of the sensor(s) having the trouble condition.

CHIME ANNUNCIATION

Your system is capable of alerting you to the opening of a door or window during the DISARMED state. To use this feature:

1. Enter your security access code, then press the CHIME Key on any Console or Keypad.
2. The Amber CHIME indicator on the Master Console will go on.
3. Should a door or window open, a single tone (beep) will sound from the Master Console and any remote interior speaker.
4. To turn off this feature, again enter your security access code and press the CHIME Key. The CHIME indicator light will go off.

Security Code + 

FIRE PROTECTION

OPERATION OF YOUR FIRE ALARM SYSTEM

Your fire alarm system is "ON" 24 hours a day, for continual protection. In the event of an emergency, the smoke detectors strategically located throughout your home will sound loudly and will automatically send signals to your Receiver/Control, triggering a loud, interrupted, rapidly alternating two-tone siren sound from your Master Console and any remote interior speaker(s). A similar sound will be produced by exterior speakers (if bells are used, there will be a pulsing bell ring). The Red FIRE indicator light and the Sensor Identification Display (for the signaling detector) at your Master Console will illuminate, and remain lit until you silence the alarm.

Should you become aware of a fire emergency before your detectors sense the

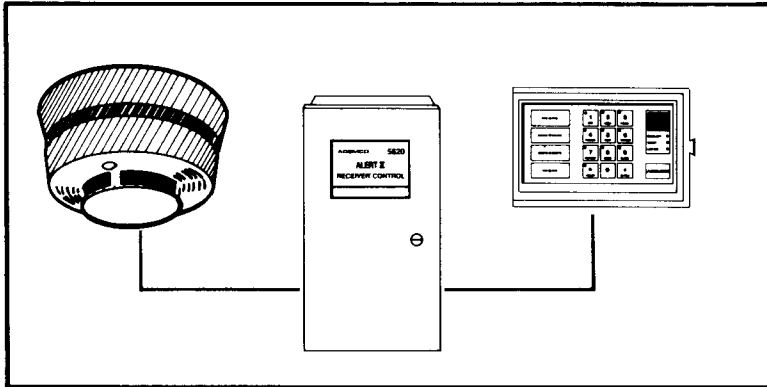

problem, go to your nearest console. Manually initiate an alarm by depressing **both** FIRE Keys simultaneously.



Your first action after an alarm should be to make sure that all occupants are safely evacuated. That done, if no flames or dense smoke are apparent, investigate the cause of the alarm.

1. Silence the alarm by entering your access code and pressing the OFF Key.
2. If the alarm continues, check all smoke detectors or heat sensors to make sure they are not responding to smoke or heat-producing objects in their vicinity. Should this be the case, eliminate the source of heat or smoke.
3. If this does not remedy the problem, there may still be smoke in the detector. Clear it by fanning the detector for about 30 seconds.
4. When the problem has been corrected, repeat Step 1 to silence the alarm.

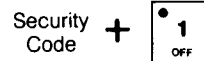

NATIONAL FIRE PROTECTION ASSN. RECOMMENDATIONS ON SMOKE DETECTORS

With regard to the number and placement of smoke detectors, we subscribe to the recommendations contained in the National Fire Protection Association's Standard #74, noted below.

Smoke detectors shall be installed outside of each separate sleeping area in the immediate vicinity of the bedrooms and on each additional story of the family living unit, including basements and excluding crawl spaces and unfinished attics.

These provisions represent the minimum number of detectors required by this standard. It is recommended that the householder consider the use of additional smoke detectors for increased protection for those areas separated by a door from the areas protected by the required smoke

detectors. The recommended additional areas

are: living room, dining room, bedroom(s), kitchen, attic (finished or unfinished), furnace room, utility room, basement, integral or attached garage and hallways. However, the use of the additional detectors remains the option of the householder.

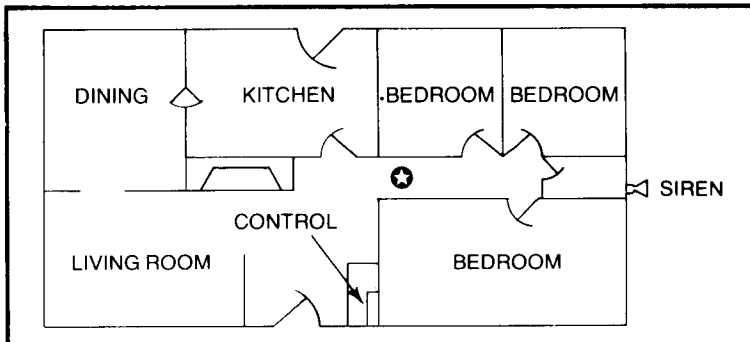

BEST RESIDENTIAL DETECTOR PLACEMENT: BETWEEN BEDROOMS and REST OF HOUSE

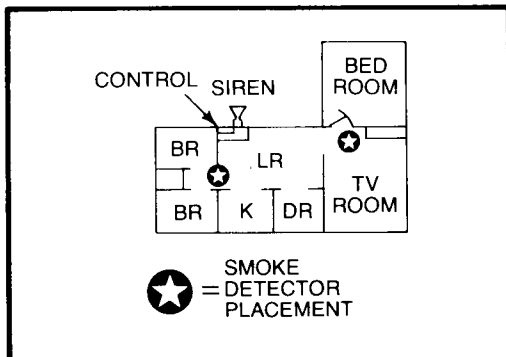

PLACE DETECTOR NEAR ALL SLEEPING AREAS

MAXIMUM FLOOR COVERAGE — DETECTORS AT TOP OF STAIRWELLS

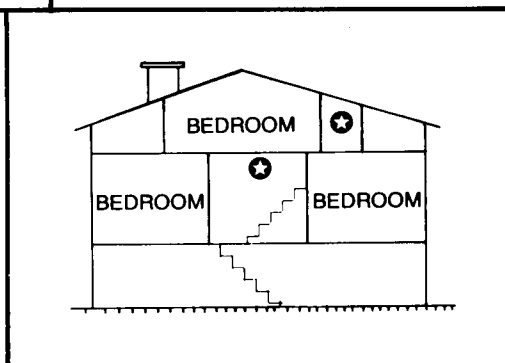

EMERGENCY EVACUATION

Every family should take steps to establish and regularly practice a plan of escape in the event of a fire. The following steps are recommended by the National Fire Protection Association and can be used as a guide in developing your own emergency plan.

1. Plan on your detector or your interior and/or exterior sounders waking the family.
2. Determine two means of escape from each room in your home, particularly the bedrooms, since most home fires occur at night when everyone is asleep. One path of escape should lead to the door that permits normal exit from the house. The other may be a window which opens easily to permit escape should your primary path be unpassable. It may be necessary to station an escape ladder at such windows if there is an unusually long drop to ground below.
3. Sketch a floor plan of your home. Show windows, doors, stairs and rooftops that can be used to escape in the event of fire. Indicate escape routes for each room. Remember to keep these routes free from obstruction and post copies of the escape route sketch in every room.
4. Make sure that all bedroom doors are shut while the family is asleep. This will prevent deadly smoke from entering while you escape.
5. Try the door. If it is hot, check your alternate escape route. If the door is cool, use your shoulder to open it cautiously. Be prepared to slam the door if smoke or heat rushes in.
6. Crawl in the smoke and hold your breath.
7. Escape quickly; don't panic
8. Establish a common meeting place outdoors, away from your house where everyone can meet and then take steps to contact the authorities and account for those missing. Choose someone to assure that nobody returns to the house—many die going back.

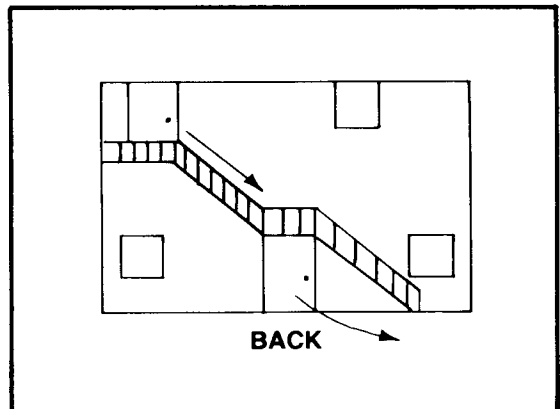
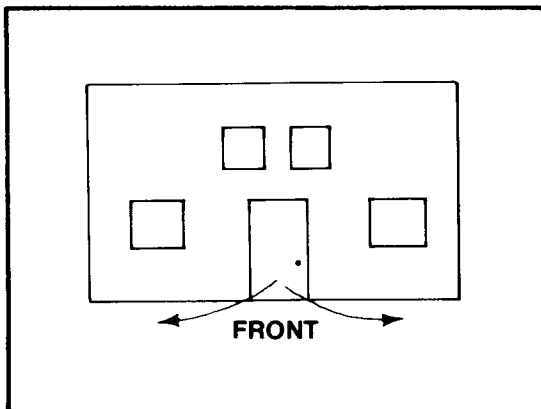
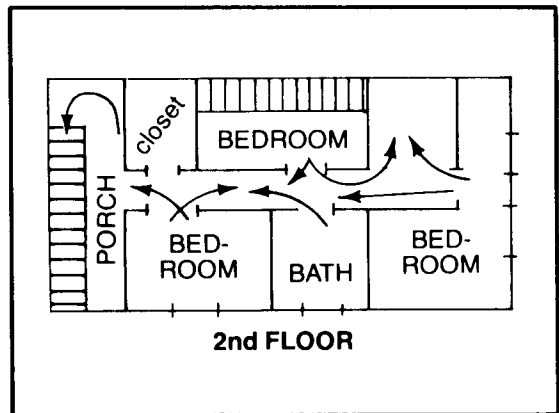
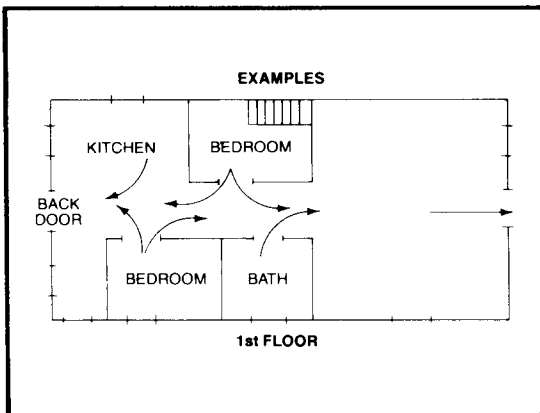

DRAW YOUR OWN EVACUATION PLAN

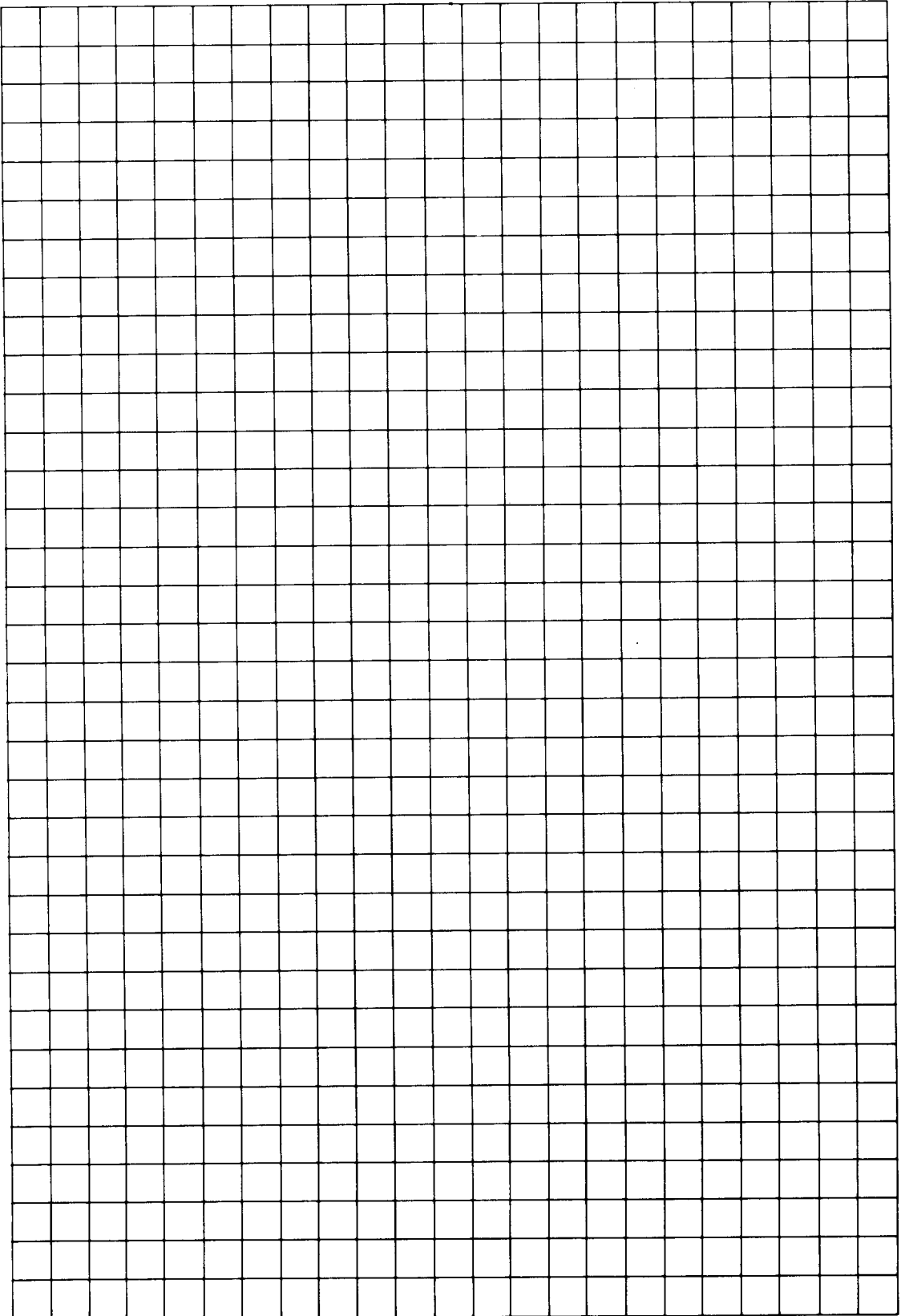

EMERGENCY ACTION

NOTE: The emergency portion of your system is always "ON", whether or not the burglary system is armed. This line of defense allows you to sound a loud panic alarm (or to send a silent emergency signal to appropriate agencies, if such provisions have been made).

HOW TO SOUND AN AUDIBLE PANIC ALARM

To trigger the alarm in the event of a personal emergency, you have several options.

1. Simultaneously depress both EMERG keys on any Console.
2. Press the button on any portable Audible Emergency transmitter*
3. Simultaneously depress the LIGHTS and ENTER keys on any hand-held Wireless Keypad (if system is set up for audible panic alarm).
4. Depress the LIGHTS key (for at least 2 seconds) on any hand-held Wireless Keypad (if system is set up for audible alarm instead of "Lights On").

The above actions will produce a continuous, two-tone siren sound from your Master Console and any remote interior speakers. Your exterior siren or bell will also sound. The Red EMERG indicator light on your Master Console will illuminate.

To turn alarm off, enter your security access code and depress the OFF Key at the Master Console or Remote Wireless Keypad.



OR

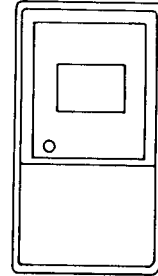

Security Code +



HOW TO SEND A SILENT EMERGENCY ALARM

NOTE: Usage of this feature is relevant only if optional communication devices are connected to a local police department or alarm monitoring service.

You have several options:

1. Simultaneously press both POLICE keys on any Console.
2. Press the button on any portable Silent Emergency transmitter*
3. Simultaneously depress the LIGHTS and ENTER keys on any handheld wireless keypad (if system is set up for silent police alarm).
4. Enter your Duress Code to disarm the system.

The latter is your normal master or temporary access code with a specific change to the fourth code digit (e.g., if normal code is 1-2-3-4 and Duress Digit is programmed at time of installation as 9, Duress Code is 1-2-3-9). If the code is keyed with this special last digit, normal system disarming takes place plus the action of the next step. This code could be used if you were hostage to an intruder and were directed to disarm your system.

NOTE: If you assign a secondary code that has the Duress Digit as its fourth digit, the Duress Silent Emergency capability will not exist for this secondary code.

* The indicator light on the transmitter will come on immediately when the button is pressed, but the button must be held down for **at least 1 second** to activate an alarm.



Your system's Silent Emergency communication equipment will activate immediately, but no siren or bell will sound. The Red POLICE indicator light on your Master Console will **not** illuminate.

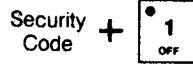

***HOW TO SOUND AN AUXILIARY PANIC ALARM**

If provisions have been made for Silent Emergency Signalling, you may use the AUXILIARY feature as an audible intrusion alarm should you detect an intruder. This assumes that your POLICE mode would be set for silent alarm and your EMERGENCY mode for personal emergency signalling purposes.

1. To trigger the alarm, simultaneously press both AUX keys on any Console.
2. A continuous two-tone siren sound will be heard from your Master Console and any remote interior speakers. Your exterior siren will similarly sound (unless a bell is used outside). The Red AUX indicator light on your Master Console will illuminate.
3. To turn off this alarm, enter your security access code and depress the OFF key at the Master Console or any Remote Wireless Keypad.

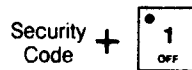

***IMPORTANT NOTE:**

Optionally, your system may have been configured to have the AUX keys activate some of the lights in your home instead of the above described alarm. These lights would remain on until the security access code was entered and the OFF key was depressed.

*In a UL Listed system there is no AUXILIARY alarm capability and "activation of lights" is not present.

In the Event of an Emergency:

Press:	Result	Application
FIRE — FIRE	Produces loud, interrupted, rapidly-alternating 2-tone siren sound.* Also sends signal to central station if optional communication devices are connected.	Use in the event of a Fire emergency.
POLICE - POLICE or press LIGHTS & ENTER keys on optional hand-held Wireless Keypad or press button (for at least 1 second) on any portable silent Emergency Transmitter	Sends silent Police alarm to central station if optional communication devices are connected. If programmed by installer, system will also produce loud, continuous, 2-tone siren sound.**	Use in the event of an intrusion or similar emergency requiring police action. If silent alarm only has been programmed by installer, AUX-AUX keys may also be used to produce an audible alarm if desired.
EMERG - EMERG or press button on any portable audible Emergency Transmitter (press for at least 1 second)	Produces loud, continuous, 2-tone siren sound.** Also sends signal to central office if optional communication devices are connected.	May be used to summon aid in the event of a personal emergency.
AUX - AUX or press LIGHTS key for at least 2 seconds on optional hand-held Wireless Keypad	Produces loud, continuous, 2-tone siren sound.** or Turns on selected lights in the home as set up by the installer. Also sends signal to central station if optional communication devices are connected.	May be used as an audible alarm to frighten away possible intruders. "Lights-On" (if available) can serve as a visible intrusion alarm.

* Exterior bell, if used, will produce a pulsing bell ring.

** Exterior bell, if used, will produce a steady bell ring.

TO TURN OFF ANY OF THE ABOVE ALARMS, ENTER SECURITY ACCESS CODE AND PRESS THE OFF KEY ON ANY CONSOLE OR KEYPAD.

EMERGENCY PHONE NUMBERS

Alarm Monitoring Station _____

Fire Department _____

Police _____

Gas/Electric Company _____

Neighbor _____

Doctor _____

Hospital _____

Ambulance _____

Emergency _____

SERVICING INFORMATION:

Your local Ademco dealer is the man best qualified to service your alarm system. Arranging some kind of regular service program with him is advisable. Your local Ademco dealer is:

TESTING PROCEDURES

HOW TO TEST YOUR BURGLARY SYSTEM

IMPORTANT: It is recommended that your burglary system be tested at least once a week, as follows:

1. Make sure that the system is disarmed. At the Master Console, enter your security access code and press the TEST key. **Reminder: In the TEST mode, your Console will sound a single tone (beep) at 30-second intervals if no messages are received from any of your sensors.**
2. Open each protected door and window. Each action should produce two tones (beeps) from your Master Console or remote interior speaker(s). Sensor identification numbers of all open doors and windows will appear in sequence on the Master Console display. Close all windows and doors. There will again be two tones (beeps) as each is closed. Ascertain that no identification numbers remain visible on the Master Console.
3. Walk in front of your interior motion detector(s) (if used). Listen for two tones (beeps) each time the detector senses your movement. While it is activated, its identification number will be displayed on your Master Console for from one to ten seconds, depending on motion in front of the detector.
NOTE: The interior motion detector will only sense motion once every three minutes so as to conserve battery life.
4. Press the buttons on each portable panic (POLICE or EMERGENCY) transmitter and listen for two tones (beeps). No identification number for these units will appear on your Master Console display.
5. To test your fire alarm system, follow the procedure in the next section.
6. To turn off the TEST MODE, enter your security access code and press the OFF key.

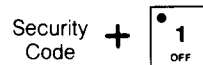
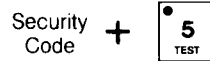

CAUTION:

THE RECEIVER/CONTROL'S BATTERY IS REQUIRED TO BE CONNECTED FOR PROPER ALARM OPERATION. AFTER A SUSTAINED AC POWER OUTAGE, THE SYSTEM'S BATTERY MAY REQUIRE A RECOVERY PERIOD OF UP TO 24 HOURS BEFORE IT IS AGAIN CAPABLE OF SOUNDING AND COMMUNICATING ALARMS.

HOW TO TEST YOUR FIRE ALARM SYSTEM

IMPORTANT: It is recommended that your fire alarm system be tested at least once a week, as follows:

1. Place the system in the TEST mode as described in step 1 of the previous section.
2. Depress the TEST button steadily on one of your smoke detectors. In approximately 10 to 20 seconds, the detector's horn will start to sound. Approximately 10 to 30 seconds later, your Master Console or remote interior speaker(s) will emit two tones (beeps) each time (every 6 seconds) an alarm signal is received from the smoke detector.

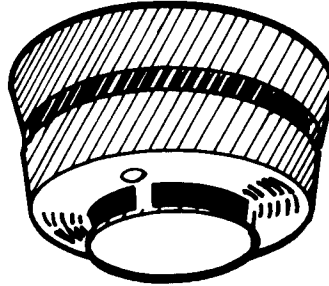

3. Release the TEST button. The smoke detector's horn will continue sounding for up to 20 seconds. Within 6 seconds after the horn stops, the smoke detector's identification number will be displayed on the Master Console concurrent with two tones (beeps) emitted by the Console. During the next 4 to 30 seconds, another pair of sounds will be emitted at the Console as the detector's ID display at the Console clears.

Security Code + 

4. Repeat 2 and 3 for all detectors.
5. Turn off the TEST mode by entering your security access code and pressing the OFF key.

TROUBLE CONDITIONS

RESPONDING TO A LOW BATTERY CONDITION

When any sensor transmitter battery has approximately 30 days of life remaining, the sensor transmitter sends a "low battery" message. If the system is armed (such as when you are asleep) the Master Console will not deliver the message until the system is DISARMED. *If the system is disarmed, the Master Console indicates the condition immediately.

*In a UL Listed installation, the system will immediately notify you of a low battery condition, even if the system is in an "armed" state.

1. The "LOW BAT" message appears on your Master Console's display, and rapidly pulsing tones (beeps) will be heard from your Master Console and any remote interior speaker(s). Numeric identification of the sensor(s) with battery problems appears on the Master Console's display. Portable Panic Transmitter IDs appear as 30 or 31, depending upon installer's setting, and all Remote Wireless Keypads are denoted by a display of 00.

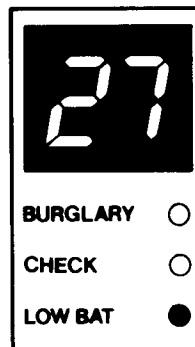

2. Either replace the battery of any identified sensor, or contact your service company for that purpose.
3. After battery replacement, DISARM the system. Activate any affected sensor (press button or key, open a door or window, walk in front of a motion detector).
4. At any Console or Keypad enter your access code. Arm your system (either HOME or AWAY), and then immediately DISARM it (enter access code, then depress OFF key). This resets the low battery communication signal to your service company.

LOW BATTERY CONDITION (CONT'D)

NOTE: Occasionally, the "LOW BAT" message indicator will remain lit after these steps. If so, remove the new battery. Check its clips and reshape them for tight fit. Reinsert the battery and repeat the above procedure.

RESPONDING TO A SUPERVISION CHECK CONDITION

Your burglary and fire sensor transmitters are programmed to send regular "status" messages to your Receiver/Control. As long as these are received, you are unaware of this activity. However, if a sensor transmitter fails to report its status, the system detects this fact. If ARMED (such as when you are asleep), your Master Console will not indicate the supervision check condition until the system is DISARMED*. If the failure occurs during the DISARMED mode, your Master Console indicates the condition immediately.

*In a UL Listed installation, the System will immediately notify you of a supervision check condition, even if the system is in an "armed" state.

1. The "CHECK" message will appear on your Master Console display. Rapidly pulsing tones (beeps) will be heard from the Master Console and any remote interior speaker. The Sensor Identification Display will show the numeric identification of the problem sensor(s).
2. Check the identified sensor by activating it.
3. At the Master Console or any Remote Wireless Keypad, enter your security access code and press the OFF Key. If the "CHECK" message ceases and remains blank for several hours, the sensor transmitter is all right and the cause of the problem has disappeared. If the same sensor transmitter keeps causing "CHECK" messages, contact your service company for assistance.

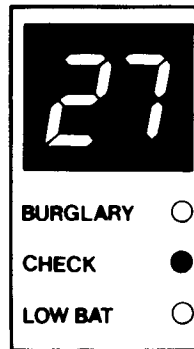

HOW TO BYPASS A MALFUNCTIONING SENSOR

Any attempt to ARM your burglary system will fail if a sensor is open. The Green READY indicator light at your Master Console will remain off. A single tone will sound from your Master Console and any remote interior speaker to indicate that your system is still in the OFF condition. Your Sensor Identification Display will show the numeric location of any open sensor(s).

1. Check the condition of any identified sensor to be sure that it is properly closed and unactivated.
2. If this is the case, yet the Master Console display continues identifying the sensor(s) as open even after another opening and closing, the problem requires the attention of your service company.
3. If you desire to arm the system with partial protection [excluding the problem sensor(s)], enter your security access code and press either the HOME or AWAY key. Then press the BYPASS key. The appropriate arming mode indicator light should illuminate, as well as the BYPASS indicator light. Depending on mode selected, either two or three tones (beeps) will be heard, as audible confirmation of arming.
4. The sensor BYPASS is automatically removed when the system is turned OFF.

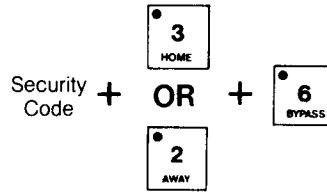

NOTE: If one or more violated sensors is bypassed and an attempt is made to either directly arm from the HOME mode to the AWAY mode or from the AWAY mode to the HOME mode, the bypass is automatically removed. As a result, the system will not arm as requested and will disarm. Both the HOME and AWAY indicator lights will be out. The READY indicator light will be out and the Sensor Identification Display will show the numeric location of the open sensor(s).

QUESTIONS AND ANSWERS ABOUT YOUR SECURITY SYSTEM

Q. I'm home. My system is armed. I accidentally set off the burglar alarm. What should I do?

A. Go to your nearest console or keypad. Enter your security access code. Press the OFF key. This will silence the interior and exterior alarm sounders. Repeat this procedure to extinguish any visual display that may be present at the Console(s). If your alarm is connected to a police department or alarm monitoring service, telephone them immediately to advise that the alarm was accidental.

Q. I have a part-time maid. How can I have her arm the system when she leaves, but have no ongoing control over it?

A. Enter a temporary access code at any console and instruct your employee in its use. The temporary code can be changed when its usefulness is over, or can be overridden by your master code, known only to your family.

Q. Cooking smoke has inadvertently triggered my fire alarm. What should I do?

A. If your system is connected to a fire department or alarm monitoring service, immediately advise them that it's a false alarm. At the nearest console or keypad, enter your access code. Press the OFF key. This will silence the alarm and reset the fire protection. Should the alarm continue, check the smoke detectors in the affected area. Clear any residual smoke in the detector's chamber by fanning the detector for 30 seconds. If alarm still continues, call your service company.

Q. How does the system help me avoid false alarms?

A. A built-in fail-safe feature prevents you from arming the system while any of its sensors are not intact. Unarmed, no false alarm can occur. In addition, outside burglary alarm sounding devices may be optionally delayed for up to 120 seconds (programmed at installation time) should you inadvertently cause your system to activate when it is armed. This permits you to turn the system off before the neighbors are disturbed, and before an alarm monitoring station or the police are notified (if your system is so connected). This option should be discussed with your installer.

Q. I become aware of an intruder in my home. What should I do?

A. If your Silent Emergency feature is connected to a police department or alarm monitoring station, depress the button on your Silent Emergency transmitter, or press both POLICE Keys on your nearest console. In any event, try to escape to the nearest safe location and call for help.

Q. I return home and my burglar alarm or my alarm memory tone is sounding. What I do?

A. Do not enter your house. Go to the nearest phone and call the police.

Q. What should I do if I'm awakened by my fire alarm?

- A. Following your pre-arranged Emergency Evacuation Plan, help all occupants safely out of the house, then contact the fire department from a safe location.

Q. I'm home alone, incur a personal emergency, and need help.

- A. If your system is connected to a police department or alarm monitoring station, you may summon help by using your portable Emergency transmitter, or the nearest console. In the latter case, simultaneously press whichever two keys (EMERG/EMERG or AUX/AUX) your installer has configured for personal emergency.

Q. I'm home, and want both intrusion protection and freedom of movement in the interior of my home.

- A. At the nearest console, enter your access code and press the HOME key, so that its related Indicator Light is ON. You will also hear three tones (beeps). The perimeter of your house is now protected.

Q. I'm home, and want an instantaneous alarm to be sounded if an intruder attempts to break in via my primary access door(s).

- A. At the nearest console, enter your access code. Press the HOME key, then the INSTANT key. The HOME and INSTANT indicator lights will go ON, and you will hear three tones (beeps). Your system is armed and the Entry Delay period has been cancelled.

Q. The POWER light on my Master Console goes out. What should I do?

- A. Though the POWER light goes out immediately upon the loss of AC power to the system, the rapidly pulsing warning tones (beeps) from your console(s) may not start until power is out for as long as 32 minutes. The time interval between loss of AC power and the commencement of the warning tones will vary anywhere between zero (immediate) and 32 minutes, as set up by the installer at time of installation.

1. If some lights are out in your home, check circuit breakers and fuses and reset or replace as necessary.
2. Check to see that your system's plug-in transformer has not been accidentally pulled out.
3. If these steps do not restore power to the system, call your service representative.

NOTE: Restoration of AC power will not return the POWER light to the ON state. Enter your security code and press the OFF key to restore the POWER light to ON.

SYSTEM REFERENCE CHART _____

HOUSE ID	
----------	--

TRANSMITTER ID	TYPE	LOCATION
01		
02		
03		
04		
05		
06		
07		
08		
09		
10		
11		
12		
13		
14		
15		
16		
17		
18		
19		
20		
21		
22		
23		
24		
25		
26		
27		
28		
29		
30		
31		

HOMEOOWNER'S INSURANCE PREMIUM CREDIT REQUEST

This form should be completed and forwarded to your homeowner's insurance carrier for possible premium credit.

A. GENERAL INFORMATION:

Insured's Name and Address: _____

Insurance Company: _____ Policy No.: _____

Ademco Receiver/Control Model No. 5620

Type of Alarm: Burglary Fire Both

Installed by: _____ Name _____ Serviced by: _____ Name _____

_____ Address _____ Address _____

B. NOTIFIES (Insert B = Burglary, F = Fire)

Local Sounding Device: _____ Police Dept.: _____ Fire Dept.: _____

Central Station: _____ Name and Address: _____

(OVER)

C. POWERED BY: A.C. With Rechargeable Power Supply

D. TESTING: Quarterly Monthly Weekly Other _____

E. SMOKE DETECTOR LOCATIONS

Furnace Area _____, Kitchen _____, Bedrooms _____, Attic _____, Basement _____, Living Room _____,
Dining Room _____, Hall _____

F. BURGLARY DETECTING DEVICE LOCATIONS:

- Front Door Basement Door Rear Door All Exterior Doors 1st Floor Windows
- All Windows All Accessible Openings, Including Skylights, Air Conditioners and Vents
- Interior Locations

G. ADDITIONAL PERTINENT INFORMATION:

Signature: _____ Date: _____



ALARM DEVICE MANUFACTURING COMPANY
165 Eileen Way, Syosset, New York 11791

WARNING
THE LIMITATIONS OF THIS ALARM SYSTEM

While this system is an advanced design security system, it does not offer guaranteed protection against burglary, fire or other emergency. Any alarm system, whether commercial or residential, is subject to compromise or failure to warn for a variety of reasons. For example:

- Intruders may gain access through unprotected openings or have the technical sophistication to bypass an alarm sensor or disconnect an alarm warning device.
- Intrusion detectors (e.g., passive infrared detectors), smoke detectors, and many other sensing devices will not work without power. Battery operated devices will not work without batteries, with dead batteries, or if the batteries are not put in properly. Devices powered solely by AC will not work if their AC power supply is cut off for any reason, however briefly.
- Signals sent by wireless transmitters may be blocked or reflected by metal before they reach the alarm receiver. Even if the signal path has been recently checked during a weekly test, blockage can occur if a metal object is moved into the path.
- A user may not be able to reach a panic or emergency button quickly enough.
- While smoke detectors have played a key role in reducing residential fire deaths in the United States, they may not activate or provide early warning for a variety of reasons in as many as 35% of all fires, according to data published by the Federal Emergency Management Agency. Some of the reasons smoke detectors used in conjunction with this System may not work are as follows. Smoke detectors may have been improperly installed and positioned. Smoke detectors may not sense fires that start where smoke cannot reach the detectors, such as in chimneys, in walls, or roofs, or on the other side of closed doors. Smoke detectors also may not sense a fire on another level of a residence or building. A second floor detector, for example, may not sense a first floor or basement fire. Moreover, smoke detectors have sensing limitations. No smoke detector can sense every kind of fire every time. In general, detectors may not always warn about fires caused by carelessness and safety hazards like smoking in bed, violent explosions, escaping gas, improper storage of flammable materials, overloaded electrical circuits, children playing with matches, or arson. Depending on the nature of the fire and/or the location of the smoke detectors, the detector, even if it operates as anticipated, may not provide sufficient warning to allow all occupants to escape in time to prevent injury or death
- Alarm warning devices such as sirens, bells or horns may not alert people or wake up sleepers who are located on the other side of closed or partly open doors. If warning devices sound on a different level of the residence from the bedrooms, then they are less likely to waken or alert people inside the bedrooms. Even persons who are awake may not hear the warning if the alarm is muffled by noise from a stereo, radio, air conditioner or other appliances, or by passing traffic. Finally, alarm warning devices, however loud, may not warn hearing-impaired people or waken deep sleepers.
- Telephone lines needed to transmit alarm signals from a premises to a central monitoring station may be out of service or temporarily out of service. Telephone lines are also subject to compromise by sophisticated intruders.
- Even if the system responds to the emergency as intended, however, occupants may have insufficient time to protect themselves from the emergency situation. In the case of a monitored alarm system, authorities may not respond appropriately.
- This equipment, like other electrical devices, is subject to component failure. Even though this equipment is designed to last as long as 10 years, the electronic components could fail at any time.

The most common cause of an alarm system not functioning when an intrusion or fire occurs is inadequate maintenance. This alarm system should be tested weekly to make sure all sensors are working properly.

Installing an alarm system may make one eligible for lower insurance rates, but an alarm system is not a substitute for insurance. Homeowners, property owners and renters should continue to act prudently in protecting themselves and continue to insure their lives and property.

We continue to develop new and improved protection devices. Users of alarm systems owe it to themselves and their loved ones to learn about these developments.

“FEDERAL COMMUNICATIONS COMMISSION (FCC) STATEMENT”

This equipment has been tested to FCC requirements and has been found acceptable for use. The FCC requires the following statement for your information:

This equipment generates and uses radio frequency energy and if not installed and used properly, that is, in strict accordance with the manufacturer's instructions may cause interference to radio and television reception. It has been type tested and found to comply with the limits for a Class B computing device in accordance with the specifications in Subpart J of Part 15 of FCC Rules, which are designed to provide reasonable protection against such interference in a residential installation. However, there is no guarantee that interference will not occur in a particular installation. If this equipment does cause interference to radio or television reception, which can be determined by turning the equipment off and on, the user is encouraged to try to correct the interference by one or more of the following measures:

- If using an indoor antenna, have a quality outdoor antenna installed.

- Reorient the receiving antenna until interference is reduced or eliminated.

- Move the receiver away from the communicator.

- Plug the communicator's power source into a different outlet so that communicator and receiver are on different branch circuits.

- Move the antenna leads away from any wire runs for communicator.

- If necessary, the user should consult the dealer or an experienced radio/television technician for additional suggestions.

The user may find the following booklet prepared by the Federal Communications Commission helpful:

“How to Identify and Resolve Radio-TV Interference Problems.”

This booklet is available from the U.S. Government Printing Office, Washington, DC 20402. Stock No. 004-000-00345-4.

Transmitters used in this system are sold under a waiver of FCC rules. Any interference that may be caused should be reported to Ademco, Customer Service, 165 Eileen Way, Syosset, NY 11791, (516) 921-6704

TRANSMITTERS USED IN THIS SYSTEM ARE SOLD UNDER A WAIVER OF FCC RULES. ANY INTERFERENCE THAT MAY BE CAUSED SHOULD BE REPORTED TO ADEMCO, CUSTOMER SERVICE, 165 EILEEN WAY, SYOSSET, N.Y. 11791, (516) 921-6704

LIMITED WARRANTY

Seller warrants its products to be in conformance with its own plans and specifications and to be free from defects in materials and workmanship under normal use and service for 18 months from the date stamp control on the product or for products not having an Ademco date stamp, for 12 months from date of original purchase unless the installation instructions or catalog sets forth a shorter period, in which case the shorter period shall apply. Seller's obligation shall be limited to repairing or replacing, at its option, free of charge for materials or labor, any part which is proved not in compliance with Seller's specifications or proves defective in materials or workmanship under normal use and service. Seller shall have no obligation under this Limited Warranty if the product is altered or improperly repaired or serviced by anyone other than Ademco factory service. For warranty service, return product transportation prepaid, to Ademco Factory Service, 165 Eileen Way, Syosset, New York 11791.

THERE ARE NO WARRANTIES, EXPRESS OR IMPLIED, OF MERCHANTABILITY, OR FITNESS FOR A PARTICULAR PURPOSE OR OTHERWISE, WHICH EXTEND BEYOND THE DESCRIPTION ON THE FACE HEREOF. IN NO CASE SHALL SELLER BE LIABLE TO ANYONE FOR ANY CONSEQUENTIAL OR INCIDENTAL DAMAGES FOR BREACH OF THIS OR ANY OTHER WARRANTY, EXPRESS OR IMPLIED OR UPON ANY OTHER BASIS OF LIABILITY WHATSOEVER, EVEN IF THE LOSS OR DAMAGE IS CAUSED BY THE SELLER'S OWN NEGLIGENCE OR FAULT.

Seller does not represent that its product may not be compromised or circumvented; that the product will prevent any personal injury or property loss by burglary, robbery, fire or otherwise; or that the product will in all cases provide adequate warning or protection. Buyer understands that a properly installed and maintained alarm may only reduce the risk of a burglary, robbery or fire without warning, but it is not insurance or a guarantee that such will not occur or that there will be no personal injury or property loss as a result. CONSEQUENTLY, SELLER SHALL HAVE NO LIABILITY FOR ANY PERSONAL INJURY, PROPERTY DAMAGE OR OTHER LOSS BASED ON A CLAIM THE PRODUCT FAILED TO GIVE WARNING. However, if Seller is held liable, whether directly or indirectly, for any loss or damage arising under this Limited Warranty or otherwise, regardless of cause or origin, Seller's maximum liability shall not in any case exceed the purchase price of the product, which shall be fixed as liquidated damages and not as a penalty, and shall be the complete and exclusive remedy against Seller.

This warranty replaces all previous warranties and is the only warranty made by Ademco on this product. No increase or alteration, written or verbal, of the obligation of this Limited Warranty is authorized.

"Ademco" is a registered trademark of Alarm Device Manufacturing Company, Division of Pittway Corp.



A DIVISION OF PITTHWAY CORPORATION